

Government Gazette Staatskoerant

REPUBLIC OF SOUTH AFRICA
REPUBLIEK VAN SUID-AFRIKA

Regulation Gazette

No. 9650

Regulasiekoerant

Vol. 558

Pretoria, 21 December 2011
Desember

No. 34876

IMPORTANT NOTICE

The Government Printing Works will not be held responsible for faxed documents not received due to errors on the fax machine or faxes received which are unclear or incomplete. Please be advised that an "OK" slip, received from a fax machine, will not be accepted as proof that documents were received by the GPW for printing. If documents are faxed to the GPW it will be the sender's responsibility to phone and confirm that the documents were received in good order.

Furthermore the Government Printing Works will also not be held responsible for cancellations and amendments which have not been done on original documents received from clients.

CONTENTS

No.

Page
No. Gazette
 No.

GOVERNMENT NOTICE

Labour, Department of

Government Notice

R. 1075 Occupational Health and Safety Act, 1993: Withdrawal of Government Notices and incorporation of health and safety standards: Driven machinery regulations 18 (1)	3	34876
--	---	-------

GOVERNMENT NOTICE

DEPARTMENT OF LABOUR

No. R. 1075

21 December 2011

WITHDRAWAL OF GOVERNMENT NOTICES AND INCORPORATION OF HEALTH AND SAFETY STANDARD IN TERMS OF SECTION 44(1) OF OCCUPATIONAL HEALTH AND SAFETY ACT, 1993

DRIVEN MACHINERY REGULATIONS 18(11)

I Thobile Lamati, appointed as Chief Inspector in terms of section 27(1) of the Occupational Health and Safety Act 1993, acting in terms of the powers vested in me by regulation 18(11) of the Driven Machinery Regulation published under Government Notice R.295 of 26 February 1988, after consultation with the Advisory Council for Occupational Health And Safety hereby withdraw Government Notice No. 8158 as published on 18 February 2005 as well as Government Notice R683 as published on 15 July 2005 and give notice that as from the date of this notice, all applications for approval from a person or organization who provides training to operators of lifting machines listed in the National Code of Practice for the Training Providers of Lifting Machine Operators will henceforth only be entertained if it is accompanied by a valid certificate issued by Transport Seta established in terms of the Skills Development Act, No 37 of 2008 which has been authorized by Chief Inspector, to carry out such accreditations.

T Lamati
Chief Inspector

NATIONAL CODE OF PRACTICE

**FOR THE
TRAINING PROVIDERS OF LIFTING MACHINE OPERATORS**

FOREWORD

This Code of Practice is to provide clarity and direction to all stakeholders directly or indirectly related to the accreditation and provision of training to lifting machine/ equipment operators in South Africa.

This document incorporates the experience acquired by the Department of Labour, the relevant stakeholders of the industry since 1992.

This Code of Practice provides direction regarding the foundation for training of all lifting machine/equipment operators with the objective of ensuring standardised training, and safety standards that will impact directly on reducing the risk of injury/death to employees/persons or damage to plant and equipment, inherent in all driven machinery operations and especially when loads are lifted or transported.

Your provincial office of the Department of Labour is available to assist in clarifying any difficulties in understanding the application of the legislation or if there are any queries regarding the accreditation contact TETA ETQA.

CONTENTS

SCOPE	7
DEFINITIONS.....	8-9
DUTIES OF AUTHORISED BODIES	10
DUTIES OF ACCREDITED TRAINING PROVIDERS	11
FIELD OF ACTIVITY	12
TRAINING SYSTEM DOCUMENTATION	12
RECORDS AND RETENTION	12
TRAINING COURSE DURATION	12
<i>OPERATORS WITH PREVIOUS CERTIFICATION</i>	13
ENTRANCE QUALIFICATION CONDITIONS.....	13
ACCREDITATION REQUIREMENTS FOR PERSONNEL.....	14
CERTIFICATION.....	15
APPENDIX 1 LIFTING MACHINE CERTIFICATION CODES	16
APPENDIX 2: GENERAL EXPLANATORY NOTES	20
APPENDIX 3: EXAMPLE OF A PRACTICAL ASSESSMENT MARK SHEET	22
APPENDIX 4: MANAGERIAL RESPONSIBILITY	25
APPENDIX 5: ACCREDITED TRAINING PROVIDERS FACILITIES RETURN.....	26
APPENDIX 6: ILLUSTRATIONS OF LIFTING MACHINE CODES	27
ATTACHMENTS: LIFT TRUCKS	36
ATTACHMENTS AND SPECIAL OPERATIONS (CRANES)	38

1. SCOPE

This Code of Practice is to provide clarity and direction to all stakeholders directly or indirectly related to the accreditation and provision of training to lifting machine/equipment/equipment operators in South Africa.

The code of practice is set in line with the ETQA accreditation criteria and guidelines.

The Code of Practice requires that all lifting machine/equipment Operators are trained regardless of the capacity of the lifting machine / equipment by accredited training providers.

Further, the code of practice covers the criteria and guidelines for lifting machine/ equipment operators, assessors, moderators and providers. Also including the criteria for approving learning/training programmes, facilities and equipment to train an operator to the required level of competence for a specific type of lifting machine/equipment.

Where other Occupational Health and Safety legislation is applicable these must be applied.

The Authorised Body shall be consulted by SAQA prior to approval and registration of unit standards for operators of lifting machines/equipment.

2. DEFINITIONS

For purposes of The Code of Practice the following definitions shall apply: -

Accredited training provider

Means a body, which delivers learning/training programmes, which culminate in specified National Qualifications Framework standards or qualifications, and manages the assessment thereof, accredited by an authorised body and approved by the Chief Inspector in terms of the Driven Machinery Regulations.

Assessment

Means the process of collecting evidence of learner's work to measure and make judgements about the achievements or non-achievements of specified National Qualifications framework standards.

Audit

Means the process undertaken to measure the quality of products or services that have already been made or delivered;

Authorised Body

Means a body accredited in terms of section 5(1)(a)(ii) of the South African Qualifications Authority Act, 1995 (SAQA Act), responsible for monitoring and auditing achievements in terms of national standards or qualifications, and to which specific functions relating to the monitoring and auditing of national standards or qualifications have been assigned in terms of section 5(1)(b)(i) of the Act, and hold authorisation by the Chief Inspector in terms of the Driven Machinery Regulation 18.11

Board

Means an executive structure of an Authorised Body.

Certificated Operator

A holder of a valid Certificate of Competence and a valid carry card.

Certificate of Competence

A certificate issued by an accredited training provider and a statement of result to a person who has demonstrated competence in a specific category of equipment according to the assessment criteria of the applicable unit standard/s and the criteria of this Code of Practice.

Lifting Machine/Equipment Codes

The lifting machine/equipment codes denote the different types of lifting machine/ equipment that are covered under this Code of Practice primarily lift-trucks (also known as forklift) and cranes. The unique codes for the different machine types are identified in Appendix 6. See Appendix 6 for typical illustrations.

Management Representative

A person employed by the Accredited Training Provider to administer and control the functionality of the accredited training provider in accordance with the provisions of the Code of Practice and in line with TETA accreditation criteria.

Moderator

Means the person that is registered by the relevant authorised body in accordance with criteria established for this purpose by SAQA that ensures the assessment of the outcomes as described in the National Qualifications Framework Standards and/or qualifications, and this Code of Practice, is fair, valid and reliable.

Quality Management System

Means the combination of documented processes used to ensure that the degree of excellence specified is achieved in line with the ETQA criteria and other relevant standards

Assessor

Means the person who is registered by the Authorised Body in accordance with criteria established for the purpose to measure the achievement of specified National Qualifications Framework Standards or qualifications and the criteria of this Code of Practice.

Statement of Results

A statement of Results issued by the Authorised Body to a person who has demonstrated competence in a specific category of equipment according to the assessment criteria of the applicable unit standard/s and the criteria of this Code of Practice.

Regulations

Means regulations as published under the Occupational Health and Safety Act, Act No.85 of 1993) and shall include other relevant legislation.

Unit Standard

Means the applicable unit standard for operating lifting machine/equipment registered on the National Qualifications Framework by the South African Qualifications Authority.

3. DUTIES OF AUTHORISED BODIES

- 3.1. The Quality Assurance Standing Committee shall make recommendations to the Board of the Authorised Body for accreditation ratification.
- 3.2. The authorised body shall maintain the latest information on the accredited training provider's, and shall forward such listings on request or at least every three months to the Chief Inspector. The following information fields are to be included; registered name of provider, postal and physical address, contact name, contact numbers, and accredited codes.
- 3.3. The authorised body shall at the last working day of January of each year or as may be requested provide the following returns for the previous calendar year to the Chief Inspector;
 - a. the number of accredited providers;
 - b. the number of learner assessments;
 - c. the number of monitoring and audits of accredited providers and
 - d. the number of certificates of competence issued both new and retrained, per code of lifting machine/equipment.
- 3.4. The authorised body shall conduct periodic audits of accredited training providers to verify compliance to the ETQA criteria. Provided that audits shall be conducted at intervals not exceeding 12 months or as determined by the Authorised Body to verify compliance to the ETQA criteria.
- 3.5. The authorised body is empowered to deaccredit a training provider after a fair process for non-conformance with the accreditation criteria. The Authorised Body shall forthwith notify the Chief Inspector of any suspension or withdrawal.

4. DUTIES OF ACCREDITED TRAINING PROVIDERS

- 4.1 After accreditation, the accredited training provider shall forward a copy of the accreditation certificate/provisional accreditation letter and relevant details of the accredited provider, to the Chief Inspector for approval under the applicable regulation.
- 4.2 Accredited training providers shall hold valid accreditation issued by an authorised body, in terms of the SAQA Act, and approval from the Chief Inspector, in terms the Driven Machinery Regulation 18.11 as published under the Occupational Health and Safety Act 1993.
- 4.3 An accredited training provider's management representative shall be responsible for the implementation and maintenance of a Quality Management System (QMS) as per the accreditation criteria and maintenance of accreditation.
- 4.4 The accredited training provider must comply to the ETQA accreditation criteria and guidelines which include but are not limited to the following –
 - a. Approved Quality Management System
 - b. Learning Programmes aligned to Unit Standards and submitted and approved by ETQA
 - c. Registered Assessors and Moderators in line with subject matter area and criteria
 - d. The management representative's delegated duties and responsibilities, including the authorisation of all certificates of competence.
 - e. The delegation of functions and scope of responsibilities for registered facilitator/s or assessor/s under the supervision and control of an accredited training provider, to maintain assurance of management's support for independent actions and decisions.
 - f. The accredited training provider shall ensure that all assessments are carried out with integrity. Measures shall be implemented to ensure that the accredited training provider and its staff are free from all pressures; financial or otherwise that could influence their judgement.
 - g. A clearly defined written policy and procedure for the resolution of any conflict that may arise from clients or other parties about the activities of the accredited provider.
 - h. The accredited training provider shall ensure confidentiality of all information obtained in the course of its activities. Proprietary rights shall be protected.
 - i. The accredited training provider shall conduct internal moderation on all aspects of its scope of accreditation plan and report to TETA external moderator to ensure effective competency declaration of learners. A procedure clarifying whom, when, what and how regarding the internal moderation process shall be conducted.
 - j. Submit per electronic data all relevant national learner record database information on a quarterly basis to authorised body.

NB:All accredited training providers will need to ensure that they have aligned to the approved and updated ETQA criteria and guidelines. The latest version can be obtained from TETA ETQA.

5. Field of activity

- 5.1 The field of activity and extent of the services for which the accredited training provider has been accredited and approved shall be detailed in the accreditation document issued by the authorised body. An accredited training provider shall not provide training on any lifting machine/equipment code and extent of services other than those for which the provider holds accreditation and approval.
- 5.2 The accredited training provider must lead to the competent operation of the lifting machine/equipment within the specific code against the registered unit standard.
- 5.3 Where certification is provided by an accredited training provider at premises other than those inspected and approved by the authorised body, then full details of the facilities and equipment used shall be recorded in the format of the facilities check sheet as detailed in Appendix 5 must be completed and readily available on request of the ETQA.

6. Training system documentation

- 6.1 The accredited training provider will keep available training system documents as required by the ETQA accreditation criteria.

7.1 Records and retention

- 7.1 All learner records shall be maintained by the accredited training provider for a minimum period of three (3) years and the records shall be accessible during this time for inspection by the Authorised Body and Department of Labour.
- 7.2 The authorised body will similarly retain for three (3) years all its relevant records.

8. Training course duration

- 8.1 The accredited training provider shall ensure that every learner is granted relevant theoretical and practical training to enable the learner to attain the prescribed competency level according to the assessment criteria of the applicable unit standard. The training course duration and instruction conditions may vary according to previous certification of the learner, as indicated below:
- 8.2 Learners without prior certification applicable to a specific lifting machine/equipment code
 - a. The hours of training shall be according to the notional learner hours of the registered unit standard.
 - b. The ratio of learners to facilitator shall not exceed 4:1 for theory training; and
 - c. The ratio of learners to demonstration/practical training per machine shall also not exceed 4:1 and all operator training must be subject to direct facilitator supervision.

Notes:

- Operators without a valid certificate/carry card shall not operate the relevant lifting machine/equipment in the working or operating environment.
- Operators of immovable machines (area specific) may be trained/ assessed in the working or operating environment only under the direct and constant supervision of a facilitator/assessor and the work area is safe and safeguarded.
- Should the operator not meet the prescribed unit standard competency further training must be arranged, for the learner to achieve the particular outcome/s.

8.3. Operators with previous certification(recertification) -

- a. Operators previously certified under the Driven Machinery Regulations whose certificates have expired or are due to expire, shall be subject to re-certification. The re-certification training shall comprise a minimum of 4 hours theoretical instruction with special focus on safety and 1 hour practical training and assessment under a ratio of 1:1 assessor supervision.
- b. The ratio of learners to facilitator shall not exceed 12:1 for theory training; and
- c. The ratio of learners to demonstration/practical training per machine shall also not exceed 4:1 and all operator training must be subject to direct facilitator supervision.
- d. Upgrades on codes for learners / operators shall be regarded as re- certification, provided that the upgrade will be of a same type of lifting machine i.e. code F1 to code F 3, code F5 to F14. C33 to C36
- e. In the event where the operator's carry card has expired for more than 90 days, the learner/operator has to undergo novice training.

Notes:

- Operators without a valid certificate shall not operate the relevant lifting machine/equipment in the working or operating environment.
- Operators of immovable machines (area specific) may be trained/ assessed in the working or operating environment only under the direct and constant supervision of a facilitator/assessor and the work area is safe and safeguarded.
- Should the operator not meet the prescribed unit standard competency further training must be arranged, for the learner to achieve the particular outcome/s.

9. Entrance qualification conditions

- 9.1 All learners of whatever status must be physically capable of performing without difficulty the tasks involved in operating the lifting machine/equipment for which they are to receive training or re-certification training and are at least 18 years of age.
- 9.2 Before commencing training or re-certification training every learner shall provide the accredited training provider with the following:

- a. A declaration or certificate from the employer confirming the medical fitness of the learner to undergo the intended training;
- b. An eye test results issued by a person trained to carry out such tests, confirming that the learner has adequate day and night vision, and depth perception (e.g. Purdue University standard vision test No. 3): Provided that a valid Professional Driver's Permit can also be accepted in lieu of the eye test results; and
- c. Shall wear the required personal protective equipment as prescribed by the employer under the General Safety Regulation 2 of the Occupational Health and Safety Act.

9.3 All new entrants intended under this code will be required to hold at least a General Education and Training Certificate, Grade 7 and must be at least 18 years of age.

a. Additional Entrance Qualification Conditions for Mobile Jib Cranes and Tower Cranes

- i. An appropriate driver's licence for the particular vehicle;
- ii. Shall be wearing protective footwear (steel toe-capped); and
- iii. As from the final approval date of the Code of Practice, all new entrants intended under these categories shall hold a General Education and Training Certificate Grade 10 (Std 8), or National Qualifications Framework level 2 (Maths and English) or equivalent.
- iv. Conditions i and iii do not apply to wall / pillar mounted jib cranes

10. Accreditation requirements for personnel

- 10.1 Every accredited training provider shall appoint in writing a full time employee as a management representative.
- 10.2 Every accredited training provider shall appoint in writing all registered facilitators/ assessors.

10.3 Management Representative

- a. The management representative shall be empowered with the necessary authority to ensure that the provisions of the Code of Practice are implemented and maintained.
- b. The accredited provider shall within 7 days notify the authorised body in writing regarding any changes to the management representative.

10.4 Facilitator

- a. A facilitator is a person having complied with the following –
 - i. Holding a valid certificate of competence or three to five years experience for each lifting machine / equipment code. Provided that in cases continuous training for a particular lifting machine / equipment code the re-certification criteria as an certificated operator may be relaxed / lapsed by the Authorised Body but limited to a maximum period of three (3) years;
The duration of initial training for a facilitator shall be at least the same as for a novice operator plus documented 120-hours practical experience).

Demonstrating competence for providing training as evaluated according to the relevant criteria.

- ii. Planned competence in line with education and training development qualification as registered with SAQA.
- iii. Knowledgeable of this code of practice; and
- b. Who is under the supervision and control of an accredited training provider.

11. CERTIFICATION

11.1 An initial certificate of competence must include the following information:
No certificates will be issued on re-certification for the same unit standard

- a. name and logo of the accredited provider or authorised body;
- b. address of accredited provider;
- c. accreditation number of provider;
- d. certificate identification or serial number;
- e. identification of Act and Regulation;
- f. initials and surname of operator;
- g. identification number of operator;
- h. lifting machine code, code description of equipment, attachments and capacity;
- i. registration number of Learning Material;
- j. restrictions of operation;
- k. registration number of facilitator and assessor;
- l. unit standard number and credit value;
- m. date of issue and
- n. authorising signature.

11.2 A carry card will be valid for a period of up to 24 months, and must be issued upon certification or re-certification and must include the following information:

- o. name and logo of the accredited provider or authorised body;
- p. certificate identification or serial number;
- q. initials and surname of operator;
- r. identification number of operator;
- s. lifting machine code, code description of equipment, attachments and capacity;
- t. restrictions of operation;
- u. unit standard number and credit value;
- v. registration number of facilitator and assessor;
- w. date of issue and validity period (24 months); and
- x. authorising signature.

11.3 The Authorised Body will issue a "Statement of Results" to competent learners / operators

11.4 No person shall operate any equipment covered by this Code of Practice without a valid certificate of competence and a carry card required by the applicable regulation published under the Occupational Health and Safety Act or any other applicable Act.

APPENDIX 1: LIFTING MACHINE CERTIFICATION CODES

Forklift Codes

For illustrations of typical codes refer to Appendix 12

Code No.	Code Description	
F1	Counterbalanced lift truck up to rated capacity of 3000 kg	
F2	Counterbalanced lift truck up to rated capacity of 7000 kg	
F3	Counterbalanced lift truck up to rated capacity of 15000 kg	
F4	Counterbalanced lift truck above a rated capacity of 15000 kg	
F5	Reach lift truck up to rated capacity of 2500 kg	
F6	Pedestrian-controlled lift truck below rated capacity of 2000 kg	
F7	Pedestrian-controlled lift truck above rated capacity of 2000 kg	
F8	Order Picker lift truck - for first and second level racking (NA/WA)	
F9	Order Picker lift truck - for all racking levels including high-rise (NA/WA)	
F10	Side Loader lift truck	
F11	Rough Terrain / Earthmoving/Agricultural Equipment with lift truck attachments,	
F12	Pallet lift truck, battery-powered for propulsion (Specify Capacity)	
F13	VNA lift truck, non-elevating cab, to service all levels	
F14	VNA lift Truck, elevating cab, to service all levels	
F15	Rail mounted stacker lift truck, non-elevating cab	
F16	Rail mounted stacker lift truck, elevating cab	

- VNA = Very Narrow Aisle
- NA Narrow Aisle
- WA Wide Aisle

Attachments & Special Equipment

- A Side-shift
- B Single Pole
- C Carton or Paper Roll Clamp
- D Crane Hook
- E Push-Pull / Slip Sheet Equipment
- F Load Rotator
- G Wire Guidance System
- H Load Extender Pantograph
- I Rotating Mast (Order Picker)
- J Tilting Bucket
- K Tandem Forks
- L Container Handling
- M Lifting Cradle (Personnel Cage)
- N Tyre handler

Code Specification on Competency Certificates

Accrediting Organisations are required to annotate certificates to clearly identify the machine category, code number and description. The description only where it significantly differs from the basic code description: i.e. code F11 (Bell Three Wheeler/Front End Loader/Excavator with Fork/grab attachment)

Special Cases

In the case of additional or new attachment/s, the learner will be required to undergo retraining and assessment to include the attachment/s. Refer also to **Training Course Duration**.

CRANES CODES

Code No.	Code Description	
C30	Overhead Crane Pendant and Radio Controlled	
C31	Overhead Crane Cab Controlled	
C32	Truck mounted Crane up to the Capacity specified on the Certificate	
C33	Hydraulic Mobile Crane up to rated capacity of 50 000 kg	
C34	Hydraulic Crane Pick up and Carry up to a rated capacity of 50 000 kg	
C35	Hydraulic Mobile Crane to the rated capacity of above 50 000 kg and as specified on the Certificate	
C36	Hydraulic Crane Pick up and Carry to the rated capacity of above 50 000 kg and as specified on the Certificate	
C37	Lattice Boom Mobile Truck Crane up to rated capacity of 50 000 kg	
C38	Lattice Boom Mobile Crawler up to rated capacity of 50 000 kg	
C39	Lattice Boom Mobile Truck Crane to the rated capacity of above 50 000 kg as specified on the Certificate	
C40	Lattice Boom Mobile Crawler Crane to the rated capacity of above 50 000 kg as specified on the Certificate	
C41	Tower Crane: Top Slewing	
C42	Tower Crane: Bottom Slewing	
C43	Hydraulic Mobile Crane up to rated capacity of 15 000 kg	
C44	Sugar Cane Crane	
C45	Ships Crane	
C46	Telescopic Boom Handler	
C47	Wharf side Crane (Rail mounted)	
C48	Reach Stacker (Telescopic Container Handler)	
C49	Straddle Carrier	
C50	Cantilever container Crane (Ship to Shore)	
C51	Scotch Derrick Crane (Ship Mounted)	
C52	Rail mounted Gantry Crane(RMG)	
C53	Mobile elevated work platform	
C54	Hoist & Winches.	
C55	Rubber Tyred Gantry Crane	
C56	Side Loader Container	
C57	Floating crane	
C58	Powered Wallmounted/Pedestal Jib crane	
C59	Wharfside Jib crane(rubber tyred)	
C60	Side boom crane	

Note that several SAQA approved unit standards cover the above codes. Providers must ensure that they are accredited on the relevant unit standards linked to these codes.

Attachments and Special Operations

- O Fly Jib (Lattice)
- P Boom Extension (Hydraulic)
- Q Counterweight Options
- R Tandem Lifts

S	Special Categories
T	Lifting Cradle (Personnel Cage)
U	Rail Mounted
V	Steam driven
W	Spreader
X	Grab / grapple/forks

Code Specification on Competency Certificates

Accredited training providers are required to annotate certificates to clearly identify the machine category, code number and description. The description only where it significantly differs from the basic code description.

Special Cases

1. It is a pre-requisite that the operator of specialised equipment will be certificated in a basic category applicable to the special machine in question.
2. Where lifting machine/s are in use that are reasonably considered to be a "one off" type and where no experience in their use is available. The manufacturer/supplier of the lifting machine will train the operator and issue a certificate of training. This can be accomplished by sending the learner/ operator to the supplier or the supplier sending a qualified instructor to the learner/operator. In such cases full course details must be made available to the relevant authorised body and the learner / operator will be required to do a theoretical and practical assessment set by the to authorised body. The authorised body will issue a statement of results *the* results of the theoretical examination to the operator's employer.

APPENDIX 2: GENERAL EXPLANATORY NOTES

These form part of the provisions of the Code

This appendix contains explanatory notes, which should be taken into account when additional clarity maybe required.

1. Accreditation of accredited training providers will remain valid whilst no non-conformances are recorded during annual audits. If any non-conformances are recorded the accredited training provider will have 30 days of the audit date to correct and provide any explanations, which may be required.
2. The responsibility of the accredited training provider shall go beyond simply carrying out training and assessments but shall include applying measures to ensure that the standards of training and assessments are maintained at all times.
3. An accredited training provider may operate as a training organisation on a client's premises. The registered facilitator shall ensure that sufficient equipment and facilities are available at the client's premises to undertake and complete the training programme to ensure the required level of competence. In all cases a record must be kept of the facilities and equipment used at the premises for inspection during audits. Any special circumstances such as the absence of suitable equipment to perform the practical tests required should be recorded and the certificate issued may require limitation endorsements.
4. Copies of all assessment papers and practical test marking sheets are required to be kept for each certificate of competence issued for audit purposes.
5. A composite organisation involved in the direct sale of equipment and which has sufficient staff to perform accredited training provider functions shall obtain accreditation and shall be required to demonstrate the following:
 - a. That adequate safeguards are in place to isolate certification staff from those involved in the other aspects of the organisation to ensure that no pressures are brought to bare which may influence registered facilitator's and assessor's judgement;
 - b. The organisation has a clearly defined policy for the resolution of conflict that may arise;
6. Accredited training providers requiring registered facilitators to use alternative course material, to their own proprietary material, must be able to demonstrate to the authorised body that they are conversant with the material and able to use it effectively.
7. An organisation applying for accreditation, as an accredited training provider must provide written approval for the use of the course material submitted unless it is clearly entirely of its own origination
8. Where conditions and/or equipment are insufficient to be able to assess an operator's performance under all types of situation then any certificate must be limited accordingly.
9. In the case of the client's only requirement is for the operator to load and off load road vehicles then the certificate of competence must be limited in either of the following manner:

- a. "Whilst in the employment of the Client"; or
- b. "For loading and off loading road vehicles only"

The second alternative is preferred, as this will adequately represent the operator's competency if the certificate of competence is presented to another employer.

APPENDIX 3 EXAMPLE OF A PRACTICAL ASSESSMENT MARK SHEET

ACCREDITED PROVIDER: _____

CANDIDATE: _____ DATE: _____

I.D. NUMBER: _____ MACHINE TYPE: _____

MACHINE MAKE: _____ MACHINE CODE: _____

COMPANY: _____ CAPACITY: _____

PRE-START CHECKS (Delete items not specific to the test machine or conditions)

Personal Protective Equipment for the work environment _____

{May include hardhats, overalls, thermal suits, goggles, earplugs as applicable}

Safety Shoes/Boots		Load Chart & Max Mass Load	
Forks/Attachments *		Position of Forks	
Load Backrest		Tyre Condition & Pressure	
Machine Condition		Wheel Nuts	
Battery Terminals		Overhead Guards	
Electrolyte Level		Engine & Transmission Leaks	
Engine Oil Level *		Hydraulic Oil Leaks	
Hydraulic Oil Level		Brake Fluid Leaks	
Brake Fluid Level*		Petrol/Diesel Leaks	
Radiator Water Level *		Gas Leaks	
Radiator Cap		Water Leaks	
Water Pump		Drivers Compartment	
Fan Belts		Mast & Chains *	
Fan Blades		Hydraulic Cylinders	
Drive Belts		Hoses Condition	
Fuel Level			

PRE-OPERATIONAL TESTS

Enter & Adjust Seat		Gauges (before and after)*	
Control levers/pedals		Ignition Key	
Raise & lower		Foot Brake*	
Tilt Front & Back		Hand/Park Brake*	
Forward & Reverse		Steering Operation*	
Horn		Attachment controls	
Lights/Indicators			

Total Items Unchecked _____

* Omission to check any one of these items would constitute the learner/operator not being yet competent of the Pre-start checks and Pre-operational test.

THEORY TEST QUESTIONS (group)

1	_____	4	_____
2	_____	5	_____
3	_____		

Penalties

Total items unchecked from Pre-start and Operational Assessment: _____ : x 2 =

* Maximum 20 penalties

1 TOTAL PRE-START AND PRE-OPERATIONAL PENALTIES _____

PRACTICAL OPERATING ASSESSMENT

(Delete items not specific to the test machine)

Penalties

Forks Bind on Entry/Withdrawal	_____	=	_____	:	x 5 =	_____
Forks not central under Load	_____	=	_____	:	x 5 =	_____
Load not at Heel of Forks	_____	=	_____	:	x 5 =	_____
Stack/De-stack with Mast Tilted	_____	=	_____	:	x 5 =	_____
Fails to Stack/De-stack Correctly	_____	=	_____	:	x 5 =	_____
Fails to Apply Park/Handbrake	_____	=	_____	:	x 5 =	_____
Fails to Place in Neutral	_____	=	_____	:	x 5 =	_____
Fails to Position Mast for Travel	_____	=	_____	:	x 5 =	_____
Fails to Position Forks for Travel	_____	=	_____	:	x 5 =	_____
Places Body Outside Cabin	_____	=	_____	:	x 5 =	_____
Bump Side of Course	_____	=	_____	:	x 10 =	_____
Fails to Look in Direction of Travel	_____	=	_____	:	x 5 =	_____
Selects Wrong Control/Direction	_____	=	_____	:	x 10 =	_____
Shunts to Stack / Un-stack	_____	=	_____	:	x 1 =	_____
Shunts to negotiate Chicane	_____	=	_____	:	x 1 =	_____
Fails to Release Park/Handbrake	_____	=	_____	:	x 5 =	_____
Fails to hold steering wheel during travel	_____	=	_____	:	x 10 =	_____
Accelerates erratically	_____	=	_____	:	x 1 =	_____
Brakes erratically	_____	=	_____	:	x 3 =	_____
Uses Controls roughly	_____	=	_____	:	x 5 =	_____
Hands on Controls	_____	=	_____	:	x 5 =	_____

CLOSE DOWN CHECKS (PARK)

Fails to Place in Neutral	_____	=	_____	:	x 2 =	_____
Fails to Set Park Brake	_____	=	_____	:	x 2 =	_____
Fails to Set Mast and Forks	_____	=	_____	:	x 2 =	_____
Fails to Shut off Gas	_____	=	_____	:	x 2 =	_____
Fails to Operate Diesel Cut Out	_____	=	_____	:	x 2 =	_____
Fails to Switch Off	_____	=	_____	:	x 2 =	_____
Fails to Remove Key	_____	=	_____	:	x 2 =	_____

2 TOTAL OPERATING AND CLOSE DOWN PENALTIES _____

TIME PENALTIES

The assessor is to complete the course to establish a fair time (minimum 15 minutes) and then add 50% to establish the maximum time to complete the operational and close down (park) assessment.

Maximum time permitted _____ Minutes _____ Seconds
 Duration of operating assessment _____ Minutes _____ Seconds

3 TIME PENALTIES (6 penalties for every 60 seconds above the maximum) ____

Summary of Penalties

- 1 PRE-START AND PRE-OPERATIONAL
- 2 OPERATING AND CLOSE DOWN
- 3 TIME

TOTAL PENALTIES

Note

A maximum of 50% of the total scored penalty points calculated by 6 penalty points per 1 minute of operational assessment time (driving time).

RESULT:

COMPETENT

NOT YET COMPETENT

Assessor: _____

Registration No: _____

Signature: _____

Date: _____

I the undersigned acknowledge that the process and results were explained to me and I accept the outcome of the assessment.

Signature/Mark of Learner: _____

APPENDIX 4: MANAGERIAL RESPONSIBILITIES

1. The person legally responsible for ensuring that the provisions of the Occupational Health and Safety Act and Regulations of 1993 are implemented on behalf of the employer is the Chief Executive Officer (C.E.O.).
2. In the case of a company without a board of directors or a closed corporation, the Owner will be the C.E.O.
3. In the case of a State department, the C.E.O. is the Director-General, not the Minister. [*Section 16 of the OHS Act, 1993*].
4. It is therefore incumbent upon the C.E.O. that proper information, instructions, training and supervision, as far as practicable are provided for the health and safety of employees. [*Section 8 (e) of the OHS Act, 1993*].
5. The necessary enforcement measures to assure the health and safety of employees are effected through a chain of command structure.
6. All lifting machine operators must be informed about what they are allowed to do. [*Sections 8 (j) and Section 37(1)(b)*].
7. The C.E.O. must ensure that a health and safety management system is in place to give effect to the provisions of the Act and regulations.
8. Anyone delegated by the C.E.O. to perform certain duties regarding information, instructions, training and supervision for employees, through the management chain of command structure and who omits to do so is contravening the Act and regulations and may be prosecuted.

APPENDIX 5: ACCREDITED TRAINING PROVIDERS FACILITIES RETURN

FACILITIES CHECK SHEET		Appendix 8
The accredited training provider is to complete this document, to record and describe any premises at which certification is offered that has not been inspected and approved by the accreditation issuing authorised body ie client's premises		
	Question	Remarks
1	Full physical address details of the premises, including name of organisation, street address, suburb/industrial area, city/ town and the location of the practical training/test route area at premises	
2	Lifting machine code/s and description/s for which training is offered at the premises	
3	Description of equipment used and identification number of equipment	
4	The lifting machine capacity or rating	
5	Description of any attachments fitted to the lifting machine	
6	A general description of the duration training, re-certification done and test route used at the premises	
7	Describe any limitations to the training and test route that may deviate from the standard routes set out in the code of practice for a specific lifting machine code.	
8	Describe any inherent dangers prevalent in the use of the lifting machine at the premises.	
	Signature of Client	Signature of facilitator

APPENDIX 6: ILLUSTRATIONS OF LIFTING MACHINE CODES
CODE DESCRIPTION

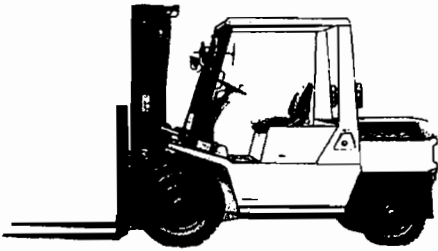

CODE F1
Counterbalanced Lift Truck
Up to rated capacity of 3000 kg



CODE F2
Counterbalanced Lift Truck
Up to rated capacity of 7000 kg

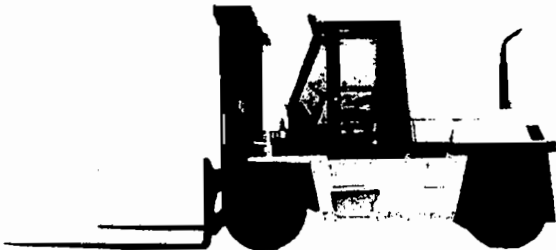

CODE F3
Counterbalanced Lift Truck
Up to rated capacity of 15000 kg

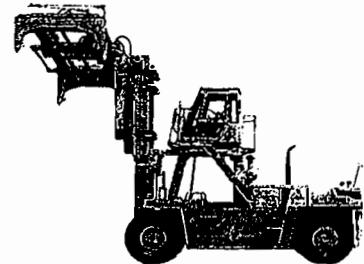

CODE F4
Counterbalanced Lift Truck
Above rated capacity of 15000kgs

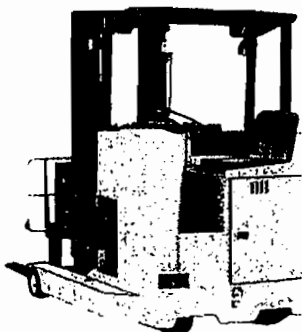

CODE F5
Reach Lift Truck
Up to Rated Capacity of 2500 kg

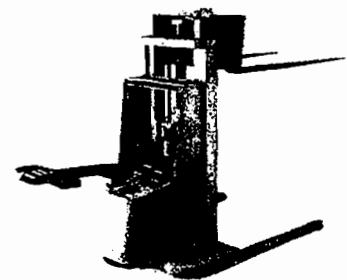

CODE F6
Pedestrian-Controlled Lift Truck
Below rated capacity of 2000 kg

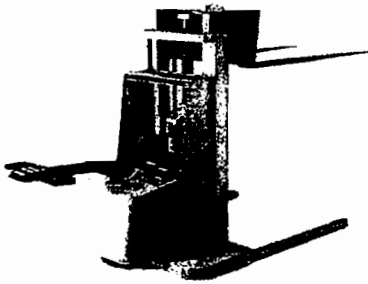

CODE F7
Pedestrian-Controlled Lift Truck
Above rated capacity of 2000 kg

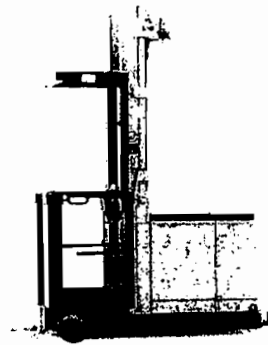

CODE F8
Order Picker Lift Truck
For First and Second Level Racking (NA/WA)

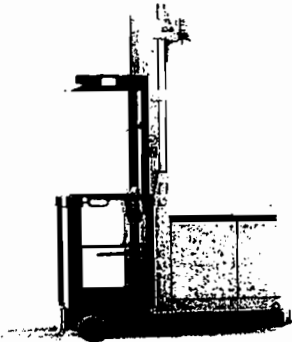

CODE F9
Order Picker Lift Truck
For All Racking Levels Including High-Rise (NA/WA)

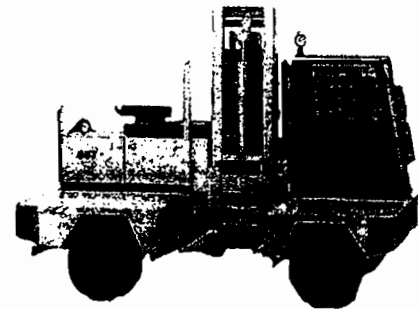

CODE F10
Side Loader Lift Truck
Capacity as Specified on the Certificate



CODE F11
Rough Terrain/Eartmoving/ Agriculture Equipment
with Lift Truck Attachments

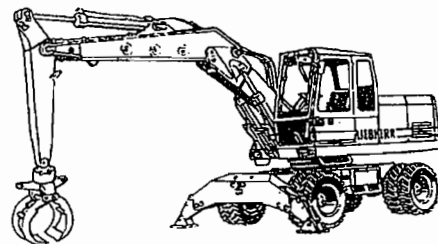

CODE F11
Rough Terrain/Eartmoving/ Agriculture Equipment
with Lift Truck Attachments

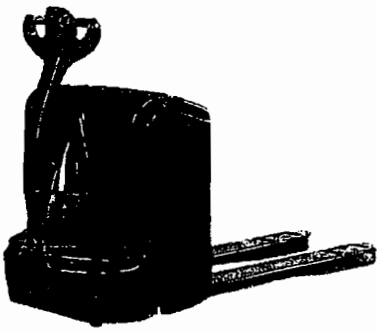

CODE F12
Pallet Lift Truck Battery Operated

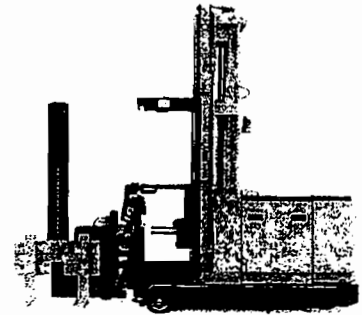

CODE F13
VNA Lift Truck Non-Elevating Cab
Service all levels

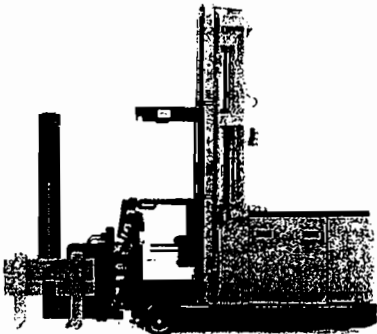

CODE F14
VNA Lift Truck Elevating Cab
Service all levels

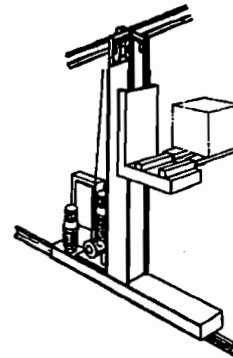

CODE F15
Railmounted Stacker Lift Truck
Non-elevating cab

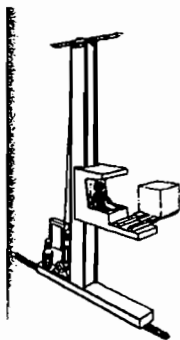

CODE F16
Railmounted Stacker Lift Truck
Elevating cab

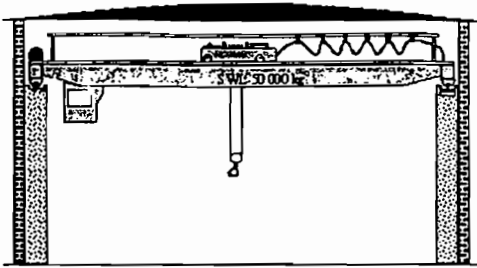

CODE C30
Overhead Crane Pendant and
Radio Controlled

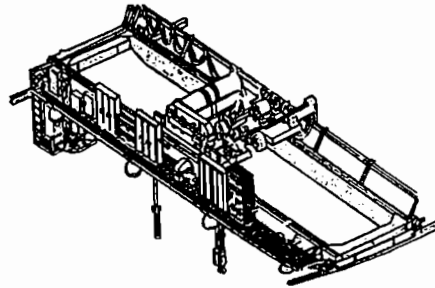

CODE C31
Overhead Crane Cab Controlled



CODE C32
Truck mounted Crane up to the
capacity stated on the certificate



CODE C33
Hydraulic Mobile Crane Up to
50 000 kg capacity

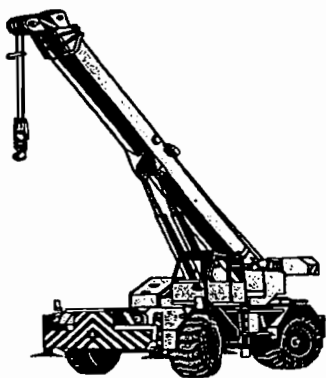

CODE C34
Hydraulic Crane Pickup and Carry up
to 50 000 kg capacity

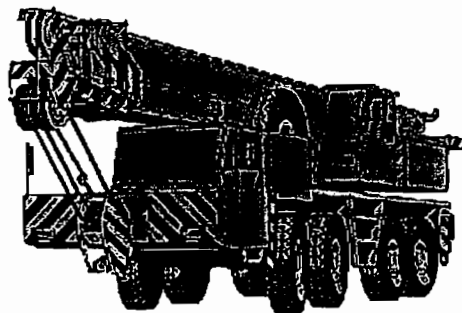

CODE C35
Hydraulic Mobile Crane above
50 000 kg capacity

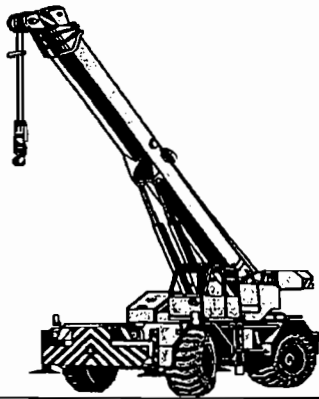

CODE C36
 Hydraulic Crane Pickup and Carry above
 50 000 kg capacity

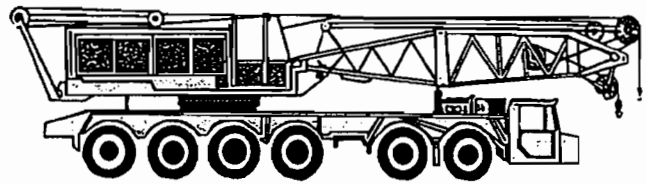

CODE C37
 Lattice Boom Mobile Truck Crane up to
 50 000 kg capacity

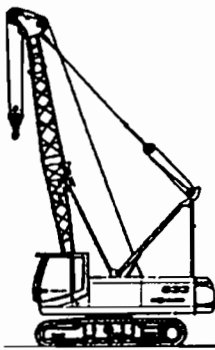

CODE C38
 Lattice Boom Mobile Crawler Crane up to
 50 000 kg capacity

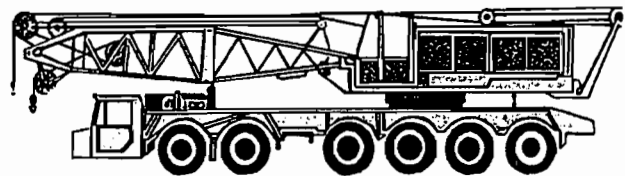

CODE C39
 Lattice Boom Mobile Truck Crane above
 50 000 kg capacity as stated on the
 certificate

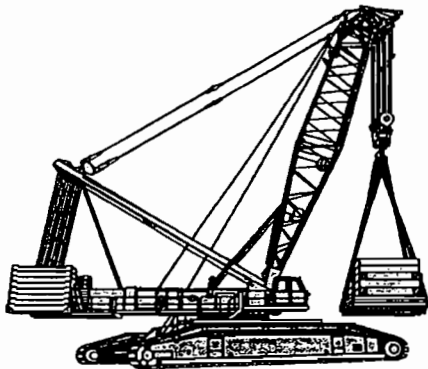

CODE C40
 Lattice Boom Mobile Crawler Crane above
 50 000 kg capacity as stated on the
 certificate

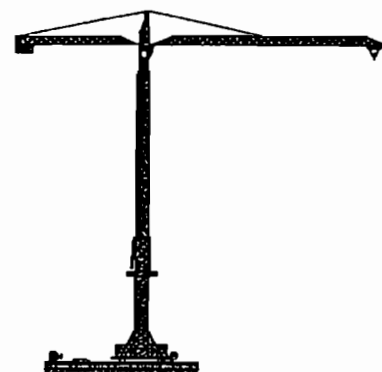

CODE C41
 Tower Crane : Top Slewing

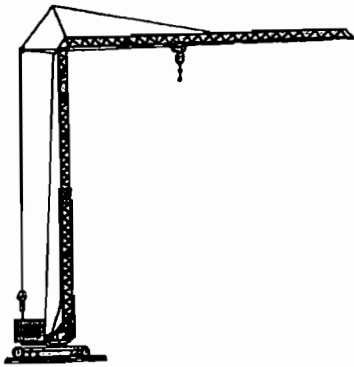

CODE C42
Tower Crane : Bottom Slewing

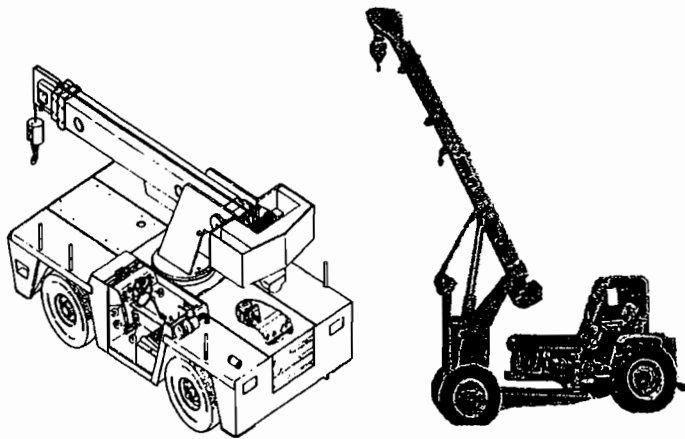

CODE C43
Mobile Hydraulic Crane up to 15000kg Capacity



CODE C44
Sugar Cane Crane

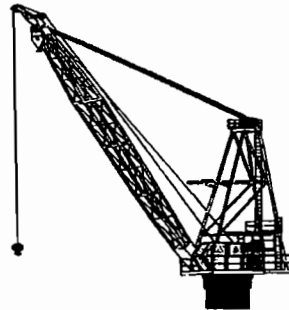

CODE C45
Ships Crane



CODE C46
Telescopic Boom Handler

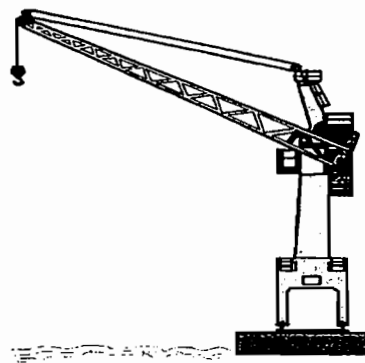

CODE C47
Wharf Side Crane : (Railmounted)



CODE C48
Reach Stacker

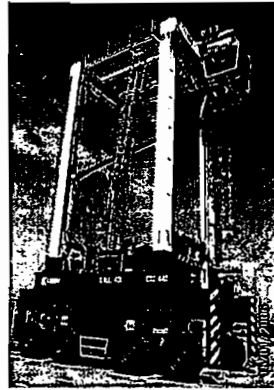

CODE C49
Straddle Carrier

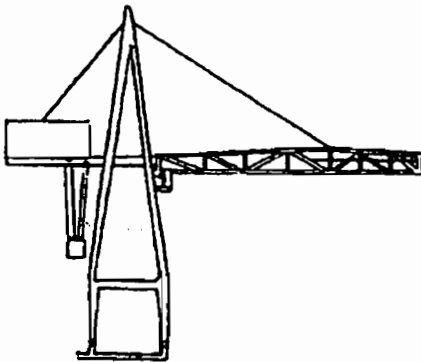

CODE C50
Cantilever Container Crane

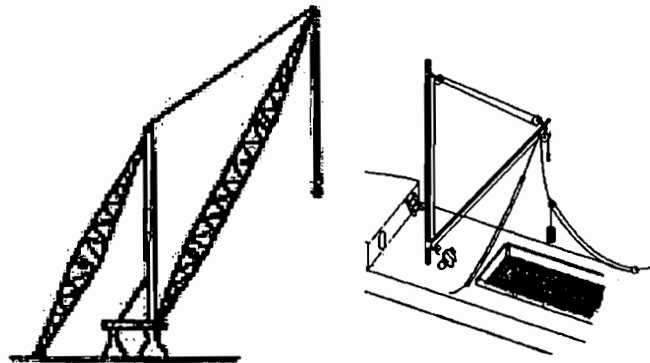

CODE C51
Scotch Derrick Crane (Ship mounted)

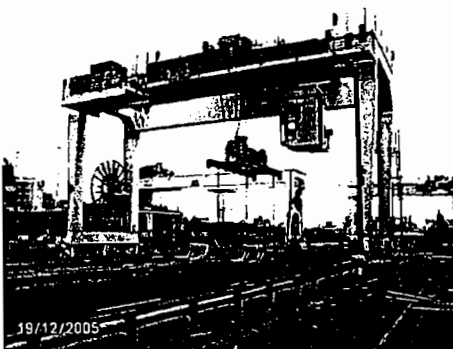

CODE C52
Rail Mounted Gantry Crane

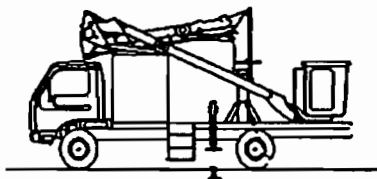
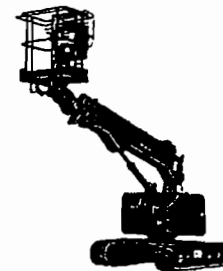

CODE C53
Mobile Elevated Work Platforms

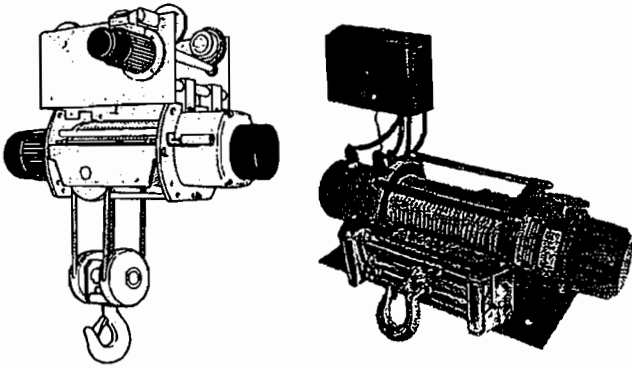

CODE C54
Hoist, & Winches

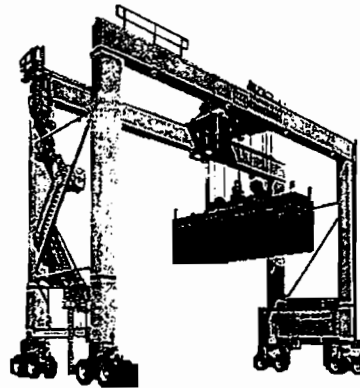

CODE C55
Rubber Tyred Gantry Crane

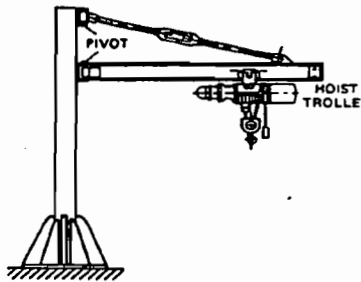

CODE C54
Pillar Mounted Jib Crane

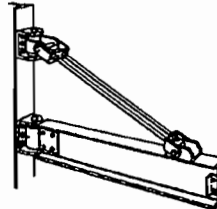

CODE C54
Wall Mounted Jib Crane

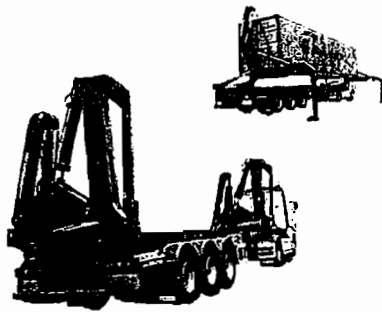

CODE C56
Side Loader Container

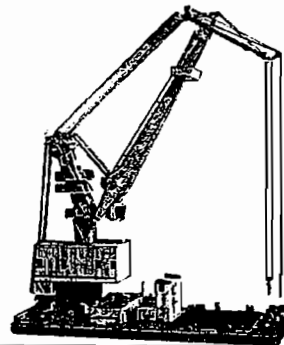

CODE C57
Floating Crane

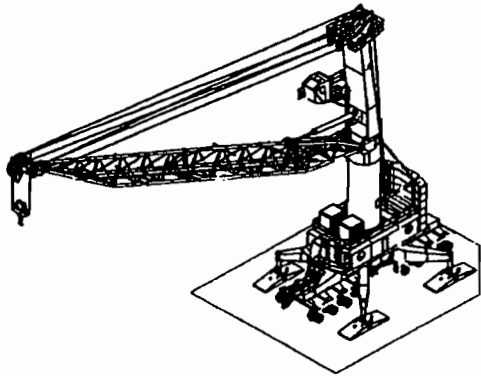

CODE C59
Wharfside Jib Crane (Rubber Tyred)

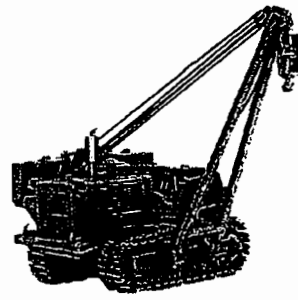

CODE C60
Side Boom Crane

LIFT TRUCK ATTACHMENTS

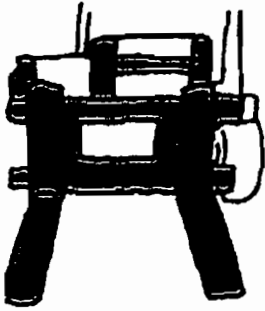

A Side- Shift



B Single POLE



C Carton or Paper Roll Clamp

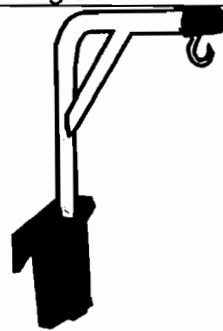

D Crane Hook

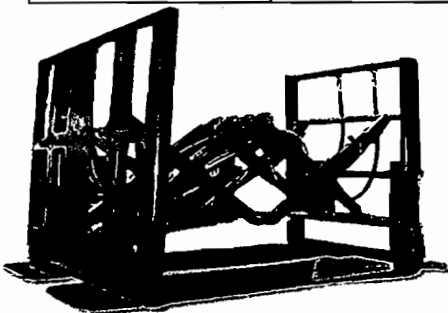

E Push Pull Slipsheet Equipment

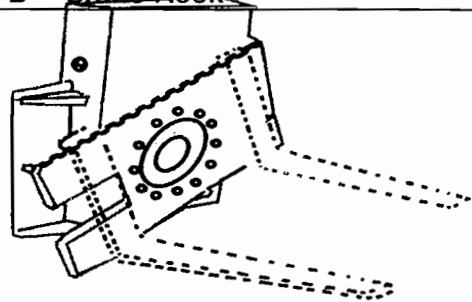

F Load Rotator

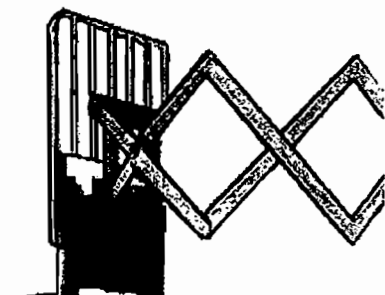

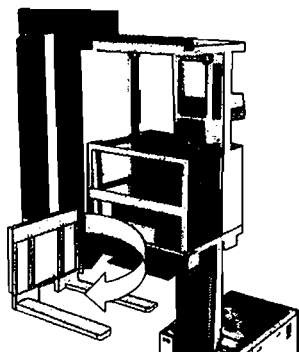

I Rotating Mast

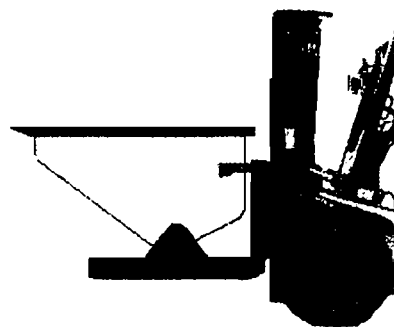

J Tilting Bucket

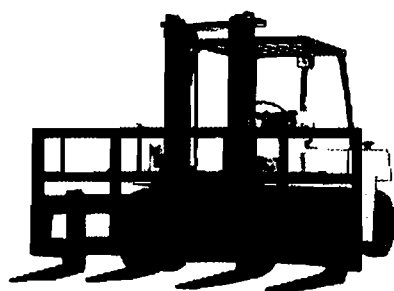

K Tandem Forks

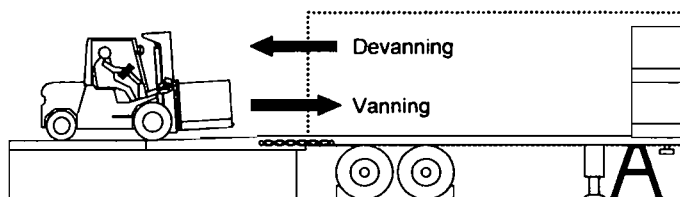

L Container Vanning and Devanning

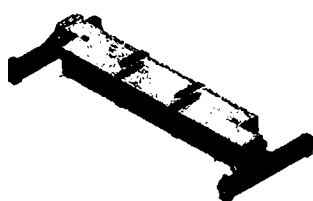

L Container Handling

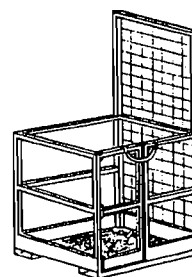

M Lifting Cradle (Personnel Cage)

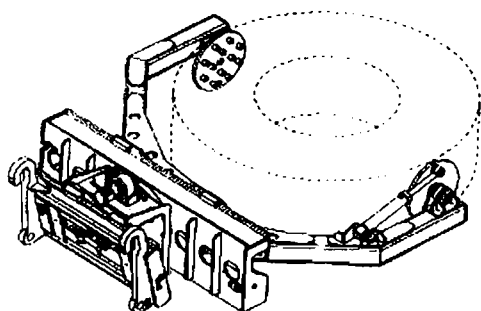

ATTACHMENTS AND SPECIAL OPERATIONS (CRANES)

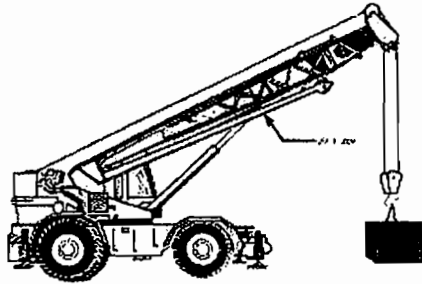

O Fly-jib (Lattice)

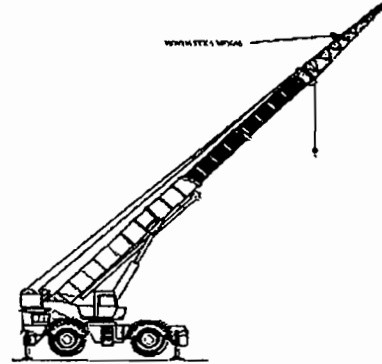

P Boom Extension (Hydraulic)

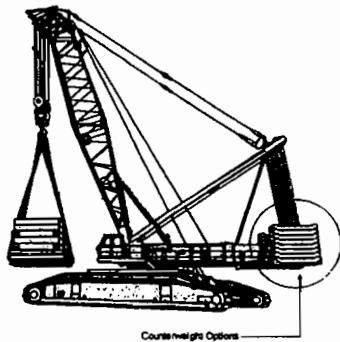

Q Counterweight Options

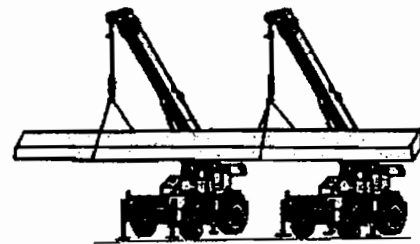

R Tandem Lifts

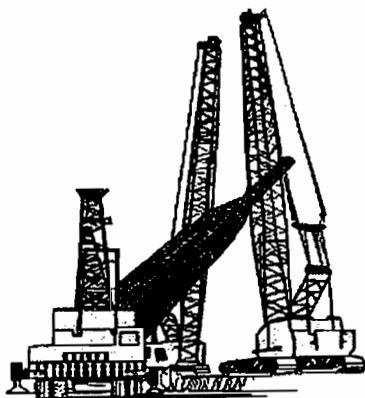

S Special Categories

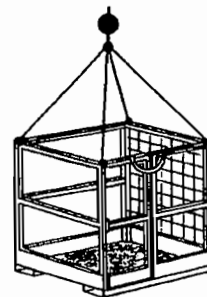

T Lifting Cradle (Personnel Cage)

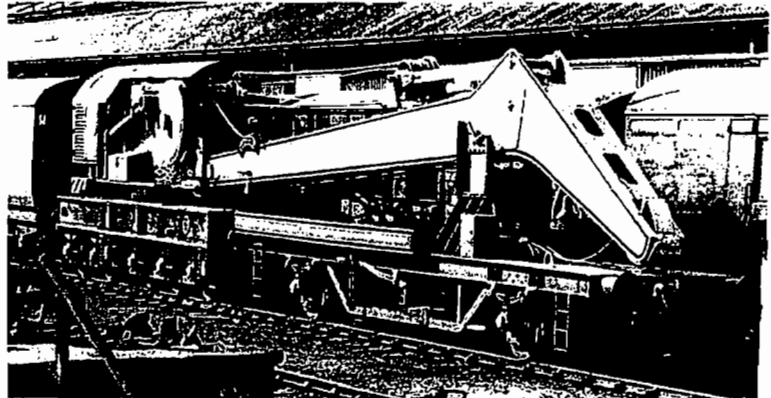
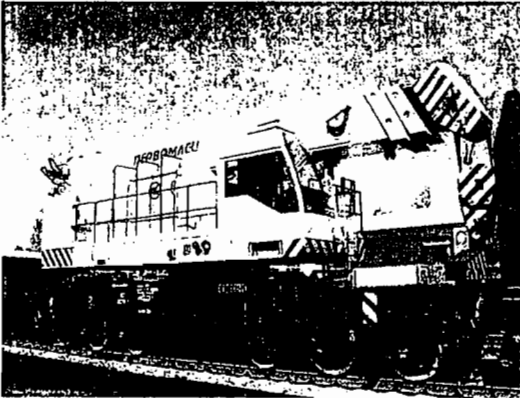

U Rail Mounted Crane

V Steam Driven Crane



W Container Spreader

X Grable / grapple

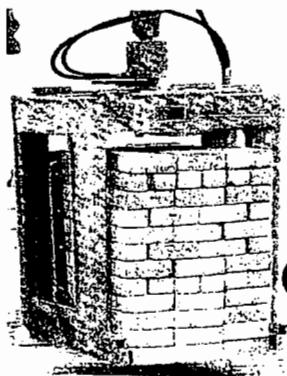

Grabbles

